



FlameHawk[®] Model 0705AD
Fiber Optic Flame Detection System

Publication 372001-14 Rev C

OBSOLETE



INTRODUCTION



This manual contains information for the FlameHawk® Flame Detection system from Forney Corporation, 16479 North Dallas Parkway, Suite 600 Addison, TX 75001.

All personnel should become thoroughly familiar with the contents of this manual before attempting to install, operate or maintain the FlameHawk® Flame Detection system. Because it is virtually impossible to cover every situation that might occur during operation and maintenance of the equipment described in this publication, personnel are expected to use good engineering judgment when confronted with situations that are not specifically mentioned herein.

PROPRIETARY NOTICE

The contents of this publication are proprietary data of Forney Corporation. Reproduction or use of any part of the publication for purposes other than the support of the equipment for which it is published is permissible only if expressly authorized in writing by Forney.

SAFETY ICON DEFINITIONS

| | |
|--|--|
|  DANGER | Indicates a hazardous situation which, if not avoided, will result in death or serious injury. |
|  WARNING | Indicates a hazardous situation which, if not avoided, could result in death or serious injury. |
|  CAUTION | Indicates a hazardous situation which, if not avoided, could result in minor or moderate injury. |
| NOTICE | Indicates unsafe practices that can result in property damage only. |

Revisions

| Revision | Date | Comments |
|----------|------------|--|
| A | 10/02/2014 | Initial Release |
| B | 06/09/2017 | Add weight |
| C | 07/11/2018 | Update Input & Return on Wiring Table, updated housing & part #s |
| | | |
| | | |
| | | |
| | | |

Table of Contents

| | |
|---|-----------|
| Section 1 System Description | 1 |
| 1.1 Introduction | 1 |
| 1.2 Operational Overview..... | 2 |
| 1.3 Detailed Specifications..... | 3 |
| 1.4 Component Descriptions..... | 4 |
| 1.5 Electronics Module..... | 4 |
| 1.6 Flame Sight Assemblies (FSAs) | 5 |
| 1.6.1 Aeroderivative Engine FSA..... | 5 |
| 1.6.2 Frame Engine Primary FSA Threaded..... | 5 |
| 1.6.3 Frame Engine Secondary FSA – Flange Design..... | 7 |
| 1.7 Fiber Optic Cables | 8 |
| Section 2 System Installation | 9 |
| 2.1 Installation | 10 |
| 2.2 FSA Installation Procedure | 10 |
| 2.2.1 Aeroderivative Engine FSA..... | 10 |
| 2.2.2 Frame Engine Primary FSA – Threaded..... | 10 |
| 2.2.3 Frame Engine Secondary FSA – Flange Design..... | 11 |
| 2.3 Fiber Optic Installation | 12 |
| 2.4 Electronics Installation | 13 |
| 2.5 System Installation Wiring..... | 14 |
| 2.5.1 Setup for 4-20mA Operation | 15 |
| 2.5.2 Set-Up for Relay Operation..... | 16 |
| 2.5.3 Set-Up for Simultaneous 4-20mA and Relay Operation..... | 17 |
| Section 3 Maintenance Procedures | 18 |
| 3.1 Recommended Cleaning Materials | 18 |
| 3.2 Procedure for Electronics End Optics | 18 |
| 3.3 Procedure for Cleaning Combustor End Optics | 19 |
| 3.3.1 Aeroderivative Type FSA..... | 19 |
| 3.3.2 Frame Engine Type FSA | 19 |
| Section 4 System Troubleshooting | 20 |
| Section 5 RMA / Warranty | 21 |
| Section 6 Spare Parts | 21 |

List of Figures

| | |
|---|----|
| Figure 1 Aeroderivative FSA..... | 5 |
| Figure 2 Frame FSA Installation Primary Zone..... | 6 |
| Figure 3 Frame Engine Primary and Secondary Installations | 6 |
| Figure 4 Frame Engine FSA with CDP Purge Fitting..... | 6 |
| Figure 5 Frame Engine FSA Flange Design | 7 |
| Figure 6 Fiber Optic Cable Compression Fitting | 8 |
| Figure 7 LED Indicators | 9 |
| Figure 8 Plot of current output vs. light energy input | 9 |
| Figure 9 GE Frame Engine FSA, Typical Primary Zone Installation | 10 |
| Figure 10 Frame Engine FSA, Typical Secondary Zone Installation..... | 11 |
| Figure 11 Configuration for 4-20 Loop | 15 |
| Figure 12 Configuration for Relay Output | 16 |
| Figure 13 Simultaneous 4-20mA and Relay Operation Diagram..... | 17 |

List of Tables

| | |
|---------------------------------|----|
| Table 1 Wiring Information..... | 14 |
|---------------------------------|----|

Section 1 System Description

1.1 Introduction

The Model 0705AD FlameHawk® flame detection system is a dual channel solid-state device designed for direct replacement of Geiger-Mueller (GM) tube flame sensors and other solid-state detection systems used on industrial and marine gas turbine engines.

Based upon many years of laboratory and field testing, the Model 0705AD significantly improves performance and reduces maintenance costs of flame sensors used on Frame and Aero-derivative gas turbine engines. The innovative approach incorporates durable fiber optic cables to transmit the spectral energy from the combustion process to the electronic module. This feature allows for remote mounting of electronics module, outside of the engine enclosure, thereby eliminating complicated cooling systems common in other flame sensors.

The Model 0705AD will work in low NOx combustors, multiple fuel applications, and with systems incorporating steam injection. No special calibration or field adjustment is required for installation.

Additional applications include:

- Industrial Boiler Flame Detection
- Auto-ignition and Flashback Detection
- Engine Acoustical Analysis
- Combustion Dynamic Analysis



Figure 1 FlameHawk Electronics Module

1.2 Operational Overview

The Model 0705AD FlameHawk® flame detection system is sensitive to spectral energy from 300nm to 450nm. Flame radiation is received through a sealed lens assembly that focuses the energy onto a fiber optic cable. The fiber optic cable transmits the spectral energy to the remote mounted electronics module.

- 1) The signal conditioning circuitry in the electronics module processes the spectral energy and provides relay and 4-20 mA outputs. Two signal strength meters incorporating LED arrays are included with the electronics module and are visible through the cover of the enclosure. The electronics module can be operated in two different modes depending on how the unit is wired at installation. When the electronics module is connected to a VDC power source, it can be operated simultaneously with 4-20 mA and relay outputs.
- 2) The module can also be operated in a stand-alone 4-20 mA two wire loop-powered circuit mode. However, the signal strength meter is operational only when VDC power is present.

The fiber optic cables and optical probes have been designed for easy installation and maintainability. Simple threaded connections are used throughout the system to allow for rapid installation without the need for special tooling. Unique features, such as a quick-release clamp on the Frame engine optical probe, have been incorporated to ease cleaning and inspection.



1.3 Detailed Specifications

| Electronics Module | | |
|--------------------------------|---|--|
| Performance | Sensitivity: | Calibrated with 1 μ W radiance (@ 370 nm) Correlates to Relay Switch Point or 7.0 mA |
| | Response Time (On / Off) | Less than 50 milliseconds |
| Electrical | 4-20 mA and Relay Using Signal Strength Meter | 18 to 32 VDC @ > 50 mA, 4-20 mA and relay. May be operated simultaneously |
| | 4-20 mA Max. Load | <650 ohms at 18 VDC to 1350 ohms at 32 VDC (linear) |
| | 4-20 mA Loop Powered | 18 to 32 VDC with 4 mA headroom |
| | Relay Rating | Resistive: 1A @ 30 VDC Load: 0.5A @ 125 VDC |
| Mechanical | Enclosure Material | Aluminum, epoxy painted |
| | Optical Interface | Female 3/8 in. compression-style fitting |
| | Electrical Interface | MS38999 / 20WD97PN or 3/4" NPT conduit hole |
| | Enclosure Mounting | 5/16 in. diameter holes (2x) |
| | Enclosure Certifications | Class I, Div. 1 & 2, Groups B, C & D; NEMA 3, 4, 4X, 7 (B, C, D), 9 (E, F, G); CENELEC — EEx d IIC, T6 or T5 |
| | Weight | 6 lbs (2.7 kg) |
| Environmental | Operating Temperature | -22°F to 158°F (-30°C to 70°C) |
| | Vibration | 8g over a range of 5 to 1200Hz |
| | Humidity | 0 to 100% relative humidity |
| Fiber Optic Cables | | |
| Mechanical | External Sheath Material | 316 Stainless steel (dual layer) |
| | Fiber Material | Fused silica — UV enhanced |
| | Optical Interface Probe | 3/8" compression-style fittings |
| | Bend Radius | 4" minimum |
| Environmental | Temperature Range | -40°F to 662°F (-40°C to 350°C) |
| Optical Probe - Aeroderivative | | |
| Mechanical | Material | Inconel 625 |
| | Engine Interface | .625 -18 UNF-2A external (male) thread |
| | Fiber Optic Interface | 3/8" compression-style fitting |
| | Window Material | Sapphire |
| Environmental | Temperature Range | -40°F to 1095°F (-40°C to 590°C) |
| | Maximum Pressure | 6895 kPa (1000 psi) |
| Optical Probe - Frame | | |
| Mechanical | Material | 316 stainless steel |
| | Engine Interface | 3/4" NPT external (male) thread or flange mount |
| | Fiber Optic Interface | 3/8" compression-style fitting |
| | Window Material | Quartz |
| | Purge Port | 1/8" NPT (if required) |
| Environmental | Temperature Range | -40°F to 572°F (-40°C to 300°C) |
| | Maximum Pressure | 4137 kPa (600 psi) |

1.4 Component Descriptions

The Model 0705AD FlameHawk® flame detection system shall consist of the following components:

- An electronics module with a built-in signal strength meter that indicates flame intensity by the number of LEDs lit in an array of ten per channel.
- Two flexible fiber optic cables that transmit NUV/Vis radiation from the combustion zone to the photovoltaic sensor.
- Two flame sight assemblies (FSA) for interfacing between the fiber optic cables and the combustion chamber.



1.5 Electronics Module

The electronic circuitry is mounted in a modified NEMA 3, 4, 4X, 7(B,C,D), 9(E,F,G) explosion and weather-proof cast aluminum enclosure consisting of a housing and a cover. The cover contains a window for viewing the LED arrays and is sealed with a heavy glass window and gasket. The cover is threaded into the housing and securely sealed with a Nitrile O-ring.

The housing has three fittings for the optical and electrical connections. The electrical connection is made through a single connector conforming to MS38999/20WD97PN or a 3/4" NPT conduit port. The opposite side of the housing has two compression-style fittings. The compression-style fittings mate the fiber optic cables to the housing and provide a seal that protects the fiber optic cable and photovoltaic sensor from the outside environment.

The electronics module is made up of four printed circuit boards (PCB's) enclosed in a metal housing. The PCB's include a display board, terminal board, and two signal conditioning boards (one for each channel). The PCB's are not user serviceable, as the modules are factory calibrated and sealed.

1.6 Flame Sight Assemblies (FSAs)

Four options of flame sight assemblies can be used with the Model 0705AD flame detection system. They are as follows:

- 00705-0185-0001: Aeroderivative FSA
- 00705-0212-0001: Frame Engine Primary FSA-Threaded
- 00705-0213-0001: Frame Engine Primary FSA- Long Focal Length
- 00705-0239-0001: Frame Engine Secondary FSA-Flange mount

1.6.1 Aeroderivative Engine FSA

(P/N 00705-0185-0001)

The Aeroderivative Engine FSA consists of a machined Inconel 625 fitting and a sapphire lens. The FSA is attached to the end of the fiber optic cable using normal compression fitting procedures. The sapphire lens assembly has a high temperature brazed ceramic to metal seal which is welded to the compression fitting. Each FSA includes .093" diameter lock wire holes for attaching to the engine and .042" diameter holes for attaching the fiber optic cable.



Figure 2 Aeroderivative FSA

1.6.2 Frame Engine Primary FSA Threaded

(P/N 00705-0212-0001 and P/N 00705-0213-0001)

The Frame Engine Primary FSA consists of a 300-series stainless steel housing that may be separated in two parts by releasing a high-pressure flange clamp in order to allow access for lens cleaning or replacement. The engine side of the housing is threaded into the combustor or pipe extension from the combustor. The other side of the housing contains a sealed quartz lens assembly.

The lens assembly is fit into a housing that is sealed to the engine side of the FSA using a high temperature gasket and a flange clamp. The fiber optic cable is attached to the FSA using normal compression fitting procedures.

For difficult sighting applications Forney also offers a version of this type of FSA that has a longer focal length (P/N 00705-0213-0001) along with eccentric offset alignment capability for use in viewing the secondary flames in low-emission combustors. Please consult factory for extra support if required.

Typical frame engine primary zone port installation:



Figure 3 Frame FSA Installation Primary Zone

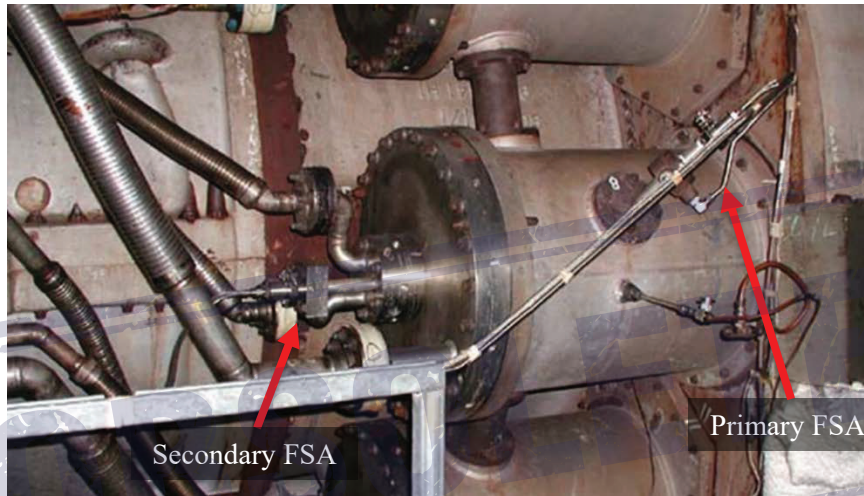

Figure 4 Frame Engine Primary and Secondary Installations

Note: In climates with high relative humidity or in applications where engines are operated in peaking service, a bleed air purge connection port (1/8" NPT) is included within the standard assembly and can be utilized if required. The standard assembly comes with a 1/8" allen pipe plug fitted. This feature allows compressor discharge pressure (CDP) air to be used to remove moisture from the FSA optical surfaces.

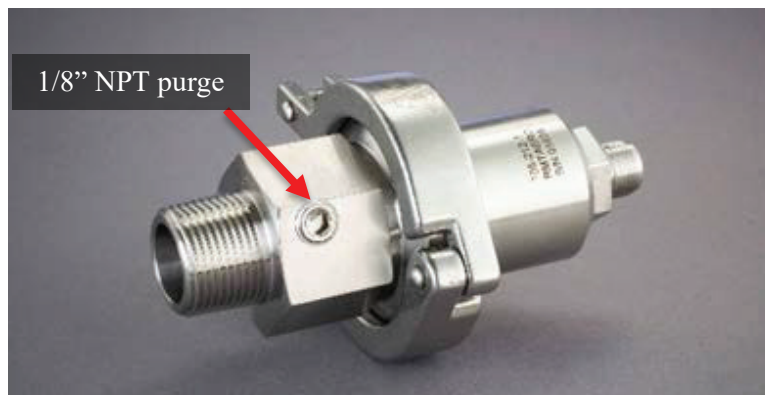

Figure 5 Frame Engine FSA with CDP Purge Fitting

1.6.3 Frame Engine Secondary FSA – Flange Design

(P/N 00705-0239-0001)

The Frame Engine FSA (incorporating a flange) is designed for installations where a standard flange conforming to GE Frame engine interface is used for mounting the flame detection system to the secondary flame port. The construction of this FSA is identical to the threaded frame engine FSA described in the previous section. However, this FSA incorporates a high-pressure flange for the engine interface.

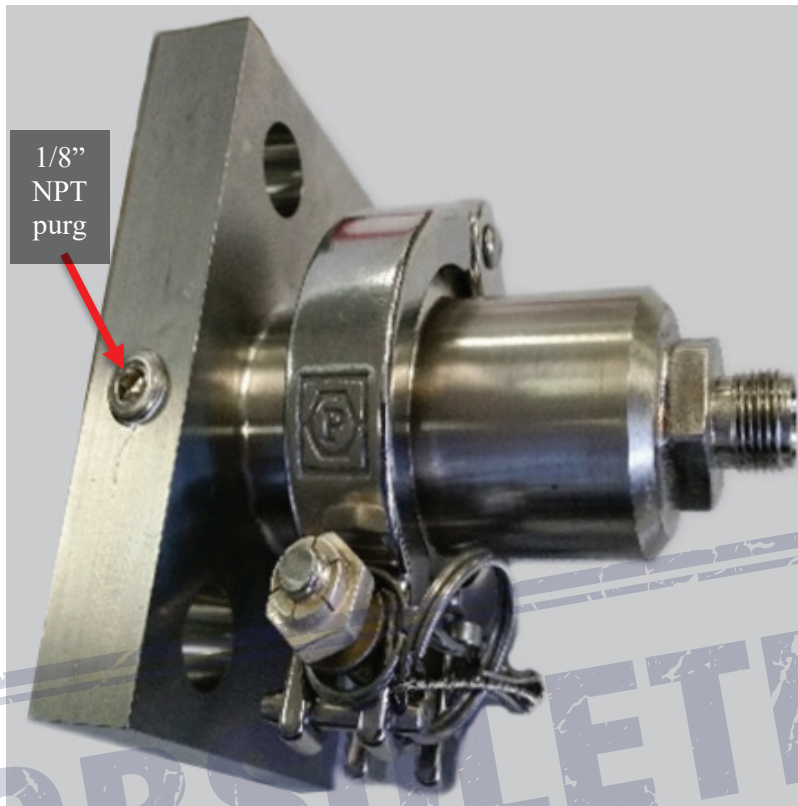

Figure 6 Frame Engine FSA Flange Design

Note: In climates with high relative humidity or in applications where engines are operated in peaking service, a bleed air purge line of 1/8" NPT is included within the standard assembly and can be utilized if required. The standard assembly comes with a 1/8" allen pipe plug fitted. This feature allows compressor discharge pressure (CDP) air to be used to remove moisture from the FSA optical surfaces.

1.7 Fiber Optic Cables

Four standard options of fiber optic cables can be used with the FlameHawk flame detection system. They are as follows:

00705-0192-0120: Fiber Optic Cable, 10 Feet Long

00705-0192-0180: Fiber Optic Cable, 15 Feet Long

00705-0192-0300: Fiber Optic Cable, 25 Feet Long

00705-0192-0480: Fiber Optic Cable, 40 Feet Long

Each fiber optic cable consists of a bundle of 19 silica/silica fibers. The fibers are contained within a fully sealed cable, designed to withstand severe environments including temperatures up to 350°C (662°F) along its entire length.



Figure 7 Fiber Optic Cable Compression Fitting

The cable ends have stainless steel fittings with compression fitting nuts and ferrules to mate and seal with the FSA and the electronics enclosure (ends are fully interchangeable).

Section 2 System Installation

The FlameHawk® flame detection system is designed to be installed and operated without any special setup. Once the unit has been installed, as instructed below, the unit will provide a "flame on" signal (greater than 4 mA) when flame is present and a "no flame" signal (less than 4 mA) when flame is absent.

Similarly, when the relay configuration is used, the presence of spectral energy indicating flame will close the contact on the relay (approximately 7mA). A loss of flame signal will provide an open indication on the relay channel.

Each of the two channels can be monitored via a signal strength meter. The meter contains a series of 10 LEDs that may be used for determining if:

- 1) LED 1 indicates 18–32 VDC is connected to the unit and active
- 2) LEDs 2-10 means there is sufficient flame radiation for a "flame on" signal
- 3) LEDs 3-10 indicate the optics require cleaning.

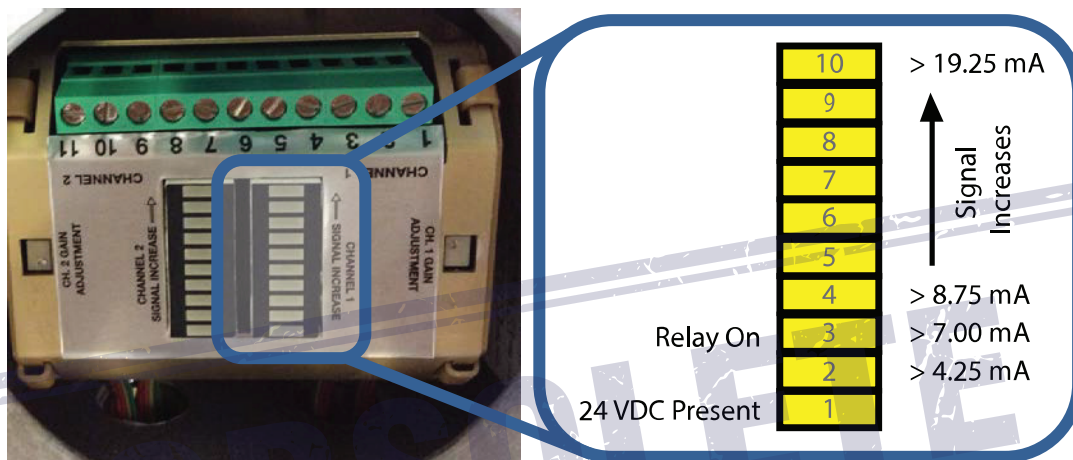

Figure 8 LED Indicators

NOTICE For the LED display to function there must be 24v power on the unit's Power Input/Power Return terminals.

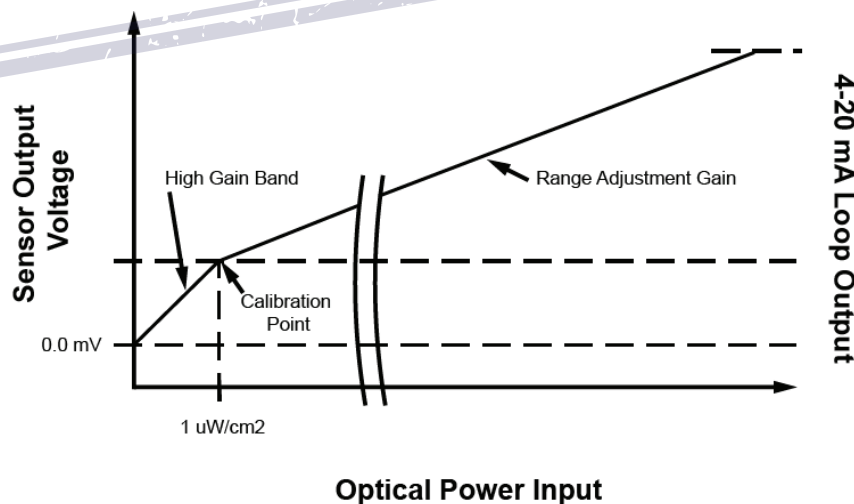

Figure 9 Plot of current output vs. light energy input

2.1 Installation

The Model 0705AD FlameHawk® flame detection system installation may be divided into three basic parts: FSA installation, fiber optic cable installation, and the electronics module mounting/installation. In general, any of the three components may be installed separately, however, since the cable is a fixed length the best approach is to install the FSA, attach the cable to the FSA, then attach the cable to supports along its path, and install the electronics module.

2.2 FSA Installation Procedure

2.2.1 Aero-derivative Engine FSA

(P/N 00705-0185-001)

Forney aero-derivative FSA's are designed to be installed directly on the engine combustor case. The FSA assemblies are made to withstand the temperatures and pressures encountered in these positions. The Forney part number 00705-0185-0001 FSA is configured for use on GE AE aero-derivative engine applications. Contact Forney for information on adapters for other applications.

Aero-derivative Engine FSA Installation Instructions

1. Install nickel washer (provided) over the FSA thread.
2. Thread adapter fitting onto existing flame detector port in the engine casing (.625-18UNF).
3. Using a 1-1/8" wrench, torque FSA to recommended value.
4. The FSA may be safety wired depending on recommended practices.

NOTICE

The window contained in each assembly is susceptible to fracture if the part is dropped. When installing the FSA and prior to cable installation, keep the FSA opening covered with a cap plug to ensure no foreign material gets into the optical path.

2.2.2 Frame Engine Primary FSA – Threaded

(P/N 00705-0212-001 and P/N 00705-0213-0001)

The threaded frame engine FSA incorporates a males 3/4" NPT for interface to the combustion system on frame engines.

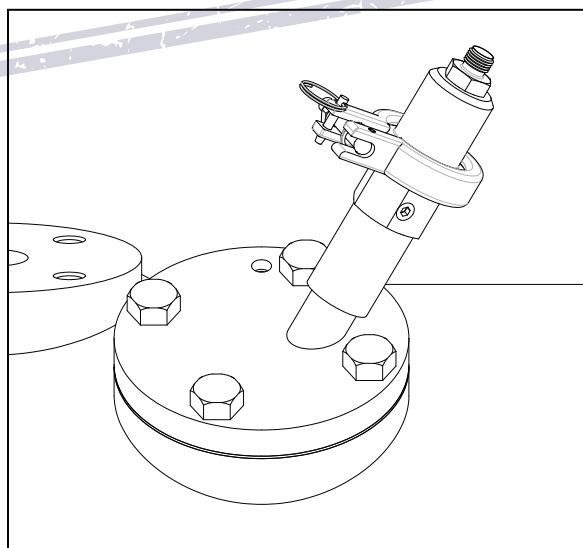

Figure 10 GE Frame Engine FSA, Typical Primary Zone Installation

Frame Engine FSA – Threaded Installation Instructions

1. Remove the safety pin from clamp and loosen the clamp (9/16” hex bolt) to allow removal.
2. Carefully remove the fiber optic-side of FSA and then the lens assembly.
3. Install a new gasket on the engine side of the FSA. A new gasket should be used each time the flange is disconnected.
4. Check to ensure lens is clean. If not, soak clean cotton swab in alcohol and wipe the lens on both sides. Use care not to leave cotton residue. Use multiple swabs if required to remove all visual signs of contamination (do not re-use dirty swabs). Blow-dry with compressed air or nitrogen or use a new swab to dry the lens surface.
5. Mount the engine side of FSA onto the mating flange and attach with appropriate hardware conforming to the engine requirements.
6. Insert the lens assembly into the engine-mounted part of the FSA.
7. Mate the fiber optic-side of the FSA onto the lens assembly.
8. Install a new gasket between the two mating flanges of the FSA. Place clamp over the mating flanges and tighten clamp to 100 in-lbs (make sure lock washer is outside clamp and safety pin lanyard is held between clamp halves).
9. Insert safety pin into the clamp.

2.2.3 Frame Engine Secondary FSA – Flange Design

(P/N 00705-0239-0001)

The flange design of the frame engine FSA incorporates a standard interface flange used on secondary flame ports on GE frame engines.

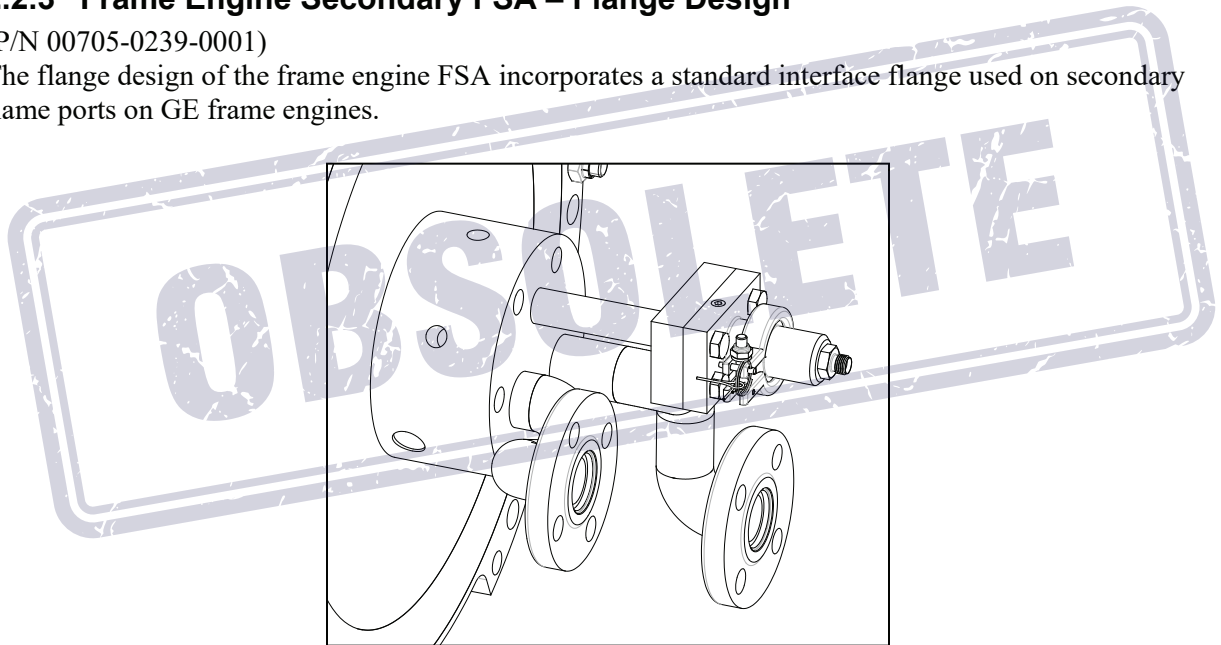

Figure 11 Frame Engine FSA, Typical Secondary Zone Installation

Frame Engine FSA – Flange Design Installation Instructions

1. Remove the safety pin from clamp and loosen the clamp (9/16” hex bolt) to allow removal.
2. Carefully remove the fiber optic-side of FSA and then the lens assembly.
3. Install a new gasket on the engine side of the FSA. A new gasket should be used each time the flange is disconnected.
4. Check to ensure lens is clean. If not, soak clean cotton swab in alcohol and wipe the lens on both sides. Use care not to leave cotton residue. Use multiple swabs if required to remove all visual signs

of contamination (do not re-use dirty swabs). Blow-dry with compressed air or nitrogen or use a new swab to dry the lens surface.

5. Mount the engine side of FSA onto the mating flange and attach with appropriate hardware conforming to the engine requirements.
6. Insert the lens assembly into the engine-mounted part of the FSA.
7. Mate the fiber optic-side of the FSA onto the lens assembly.
8. Install a new gasket between the two mating flanges of the FSA. Place clamp over the mating flanges and tighten clamp to 100 in-lbs (make sure lock washer is outside clamp and safety pin lanyard is held between clamp halves).
9. Insert safety pin into the clamp.

2.3 Fiber Optic Installation

Each of the fiber optic cables consists of a 19 fiber bundle that is encased in a stainless steel flexible conduit. The conduit protects the cable from damage and provides for attachment of the end fittings. The cables have a minimum bend radius of 4 inches.

The cable can withstand a tensile load that is inversely proportional to its length. The cable can withstand a 400 lb. load for a one foot free length. Sustainable tensile load can be estimated as follows:

$$LOAD = \frac{400}{LENGTH}$$

(For a 2 foot free length it can withstand 200 lbs., for a 25 foot free length it can withstand 16 lbs., etc.)

The ends of each of the fiber optic cables are identical. The fiber optic cable is intended to be installed similar to an electrical cable. It can be laid in a cable trough, placed in a rigid conduit, or clamped to a surface.

Fiber Optic Installation Procedure:

1. Attach fiber optic to FSA mounted on engine.
2. Using an 11/16" wrench, torque fitting to 30 ft-lbs. maximum.
3. Route the cable back to electrical enclosure.
4. Connect fiber optic cable to electrical enclosure using an 11/16" wrench, torque fitting to 30 ft-lbs. maximum.

CAUTION

Ensure that the fiber optic cables are mounted such that the minimum bend radius along the entire length is greater than 4 inches. **DO NOT** mount the fiber optic cables in contact with any surface such as hot piping or hot sections on the engine that exceed 350°C (662°F).

DO NOT mount the fiber optic cables in high traffic areas or places where they might be exposed to large external compression loads. The fibers are mounted inside a flexible stainless steel conduit that can withstand a distributive crushing load of up to 50 lbs. per linear inch without damage. If the fiber optic cable is penetrating a hazardous area the interface must be sealed to meet NFPA standards.

The customer is the best judge of how to do this for any particular installation. Forney will support these efforts as requested.

2.4 Electronics Installation

The electronics are housed within a sealed NEMA 3, 4, 4X, 7(B,C,D), 9(E,F,G) explosion and weather-proof cast aluminum enclosure. The enclosure has two mounting lugs that are compatible with 3/8" diameter bolts.

Enclosure Installation Procedure

1. The box should be mounted in a location that is within the temperature limits specified for the unit -22°F to 158°F (-30°C to 70°C). It is preferable that the box be mounted in a position where the fiber optic cables enter the box horizontally. This allows easier mounting and dismounting since the unit can rest on the lower of the mounting bolt. More importantly, it will also reduce the amount of foreign material potentially getting into the box when the fiber optic cables are removed.
2. Attach the mating harness (Forney Part Number 0705-0242-0001) to the MIL38999 connector on the side of the housing. If the NPT conduit fitting is used, ensure that proper installation is made to ensure the seal integrity of the box to prevent moisture ingress.
3. Ensure that the circular threaded cover with window is secured tightly by turning the cover clockwise.
4. Do not remove the cover unless required during troubleshooting procedures. Failure to keep a strong seal may result in moisture ingress and possible failure of the electronics.
- 5.

 **CAUTION**

The input power is 32 volts maximum. It is advisable to contact a ground immediately prior to working on the unit to avoid damaging the internal circuitry due to electrostatic discharge.

OBSOLETE

2.5 System Installation Wiring

The Model 0705AD FlameHawk® electronics unit can operate in 4 to 20mA mode, dry contact mode, or both (4-20mA and dry contact) modes simultaneously. The wiring, configuration and verification steps for each mode are described in the following sections:

Table 1 Wiring Information

| Connector Pin | Internal Terminal Strip | Parameter |
|---------------|-------------------------|-----------------------------|
| A | 1 | Channel 1: 4 – 20 mA Input |
| B | 2 | Channel 1: 4 – 20 mA Return |
| C | 3 | Channel 1: Relay |
| M | 4 | Channel 1: Relay |
| D | 5 | Power Input |
| E | 6 | Case Ground |
| F | 7 | Power Return |
| H | 8 | Channel 2: 4 – 20 mA Input |
| J | 9 | Channel 2: 4 – 20 mA Return |
| G | 10 | Channel 2: Relay |
| L | 11 | Channel 2: Relay |
| K | Open | Open |

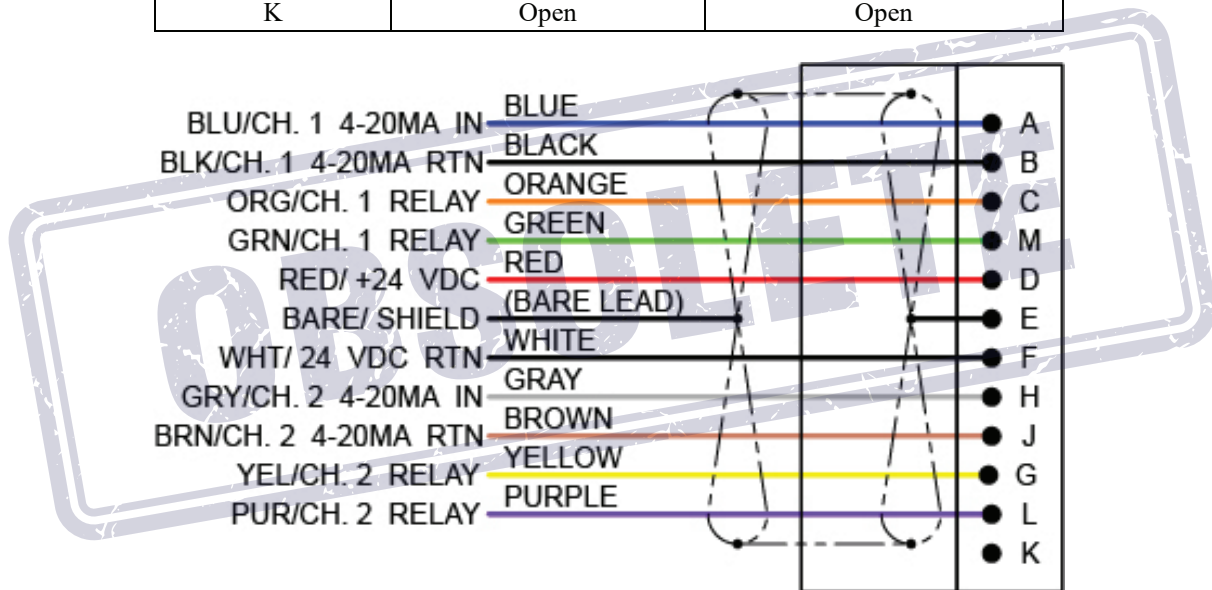

2.5.1 Setup for 4-20mA Operation

The Model 0705AD FlameHawk® electronics unit can be wired for 4-20mA operation by simply completing a 4-20mA current loop on each channel. The FlameHawk® does not require 24V power on the Power Input and Power Return terminals (5 & 7) for 4-20mA operation. Note however, that the on-board signal strength meter (10 segment LED) display requires that the electronics be powered. Refer to the figure below for 4-20mA wiring detail and terminal designations:

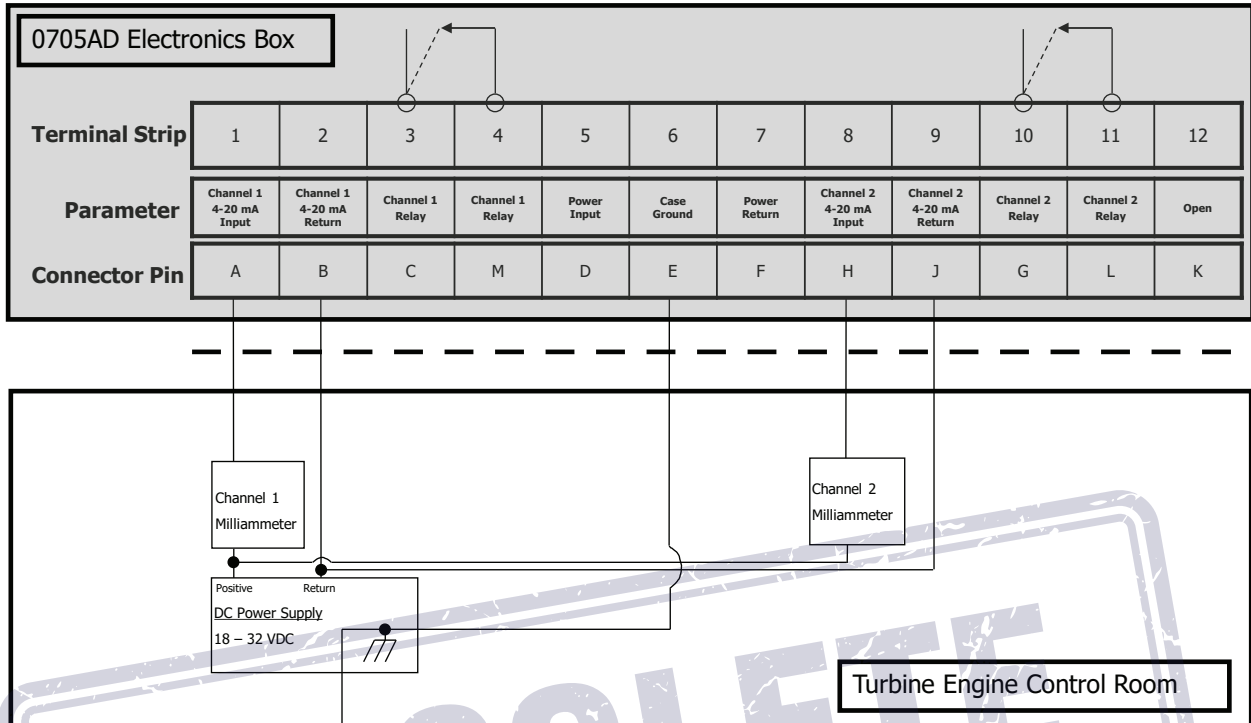

Figure 12 Configuration for 4-20 Loop

2.5.2 Set-Up for Relay Operation

Relay operating (dry contact) mode requires that power be applied to the Power Input and Power Return terminals (5 & 7). This provides both the energizing current to operate the relay coils as well as the power to illuminate the LED signal strength displays. Channel 1 connections (terminals 3 & 4) and Channel 2 connections (terminals 10 & 11) may be made without regard to +/- polarity as the relay devices are not polarity sensitive. Refer to the figure below for Relay mode wiring detail and terminal designations:

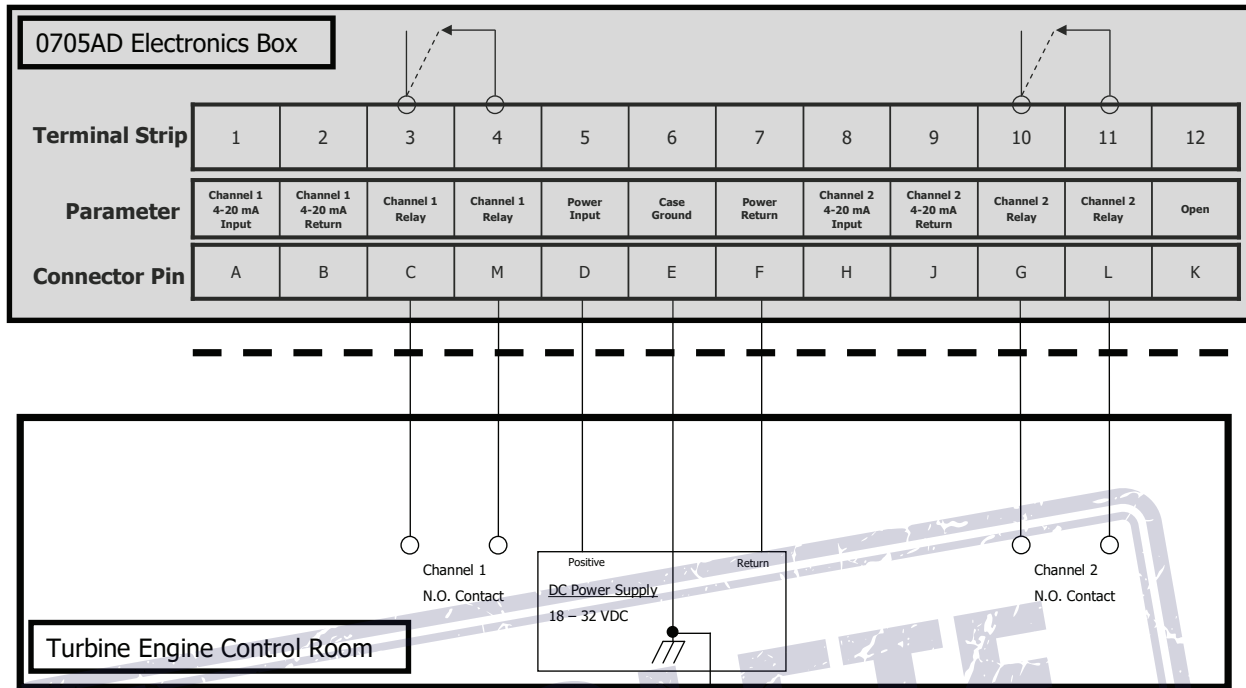
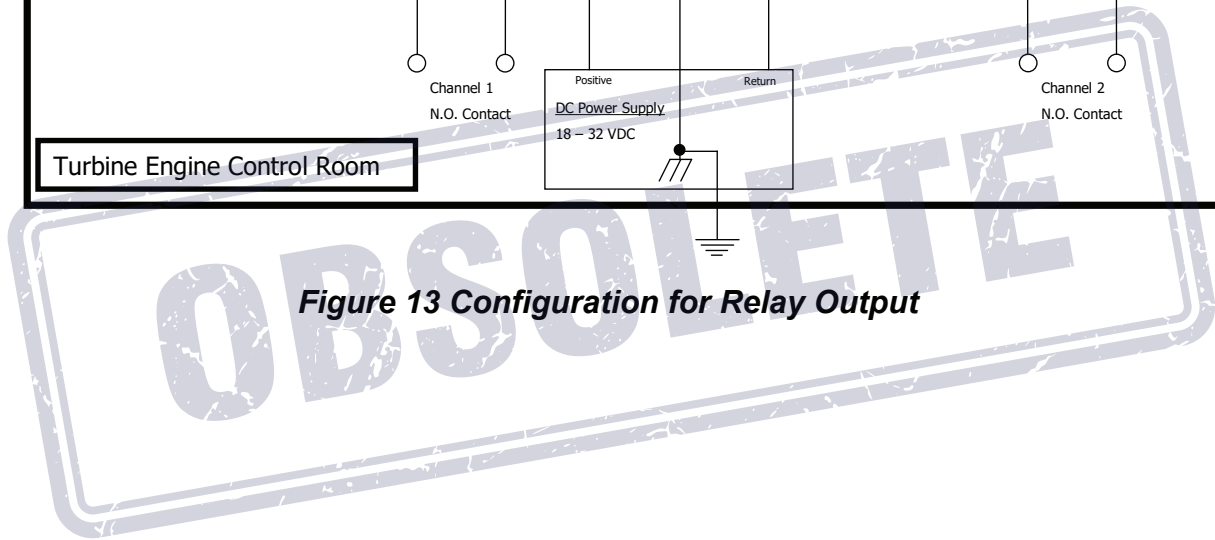

Figure 13 Configuration for Relay Output



2.5.3 Set-Up for Simultaneous 4-20mA and Relay Operation

Simultaneous operation of Relay operating (dry contact) mode requires that power be applied to the Power Input and Power Return terminals (terminals 5 & 7). This provides both the energizing current to operate the relay coils as well as the power to illuminate the LED signal strength displays. Channel 1 connections (terminals 3 & 4) and Channel 2 connections (terminals 10 & 11) may be made without regard to +/- polarity as the relay devices are not polarity sensitive.

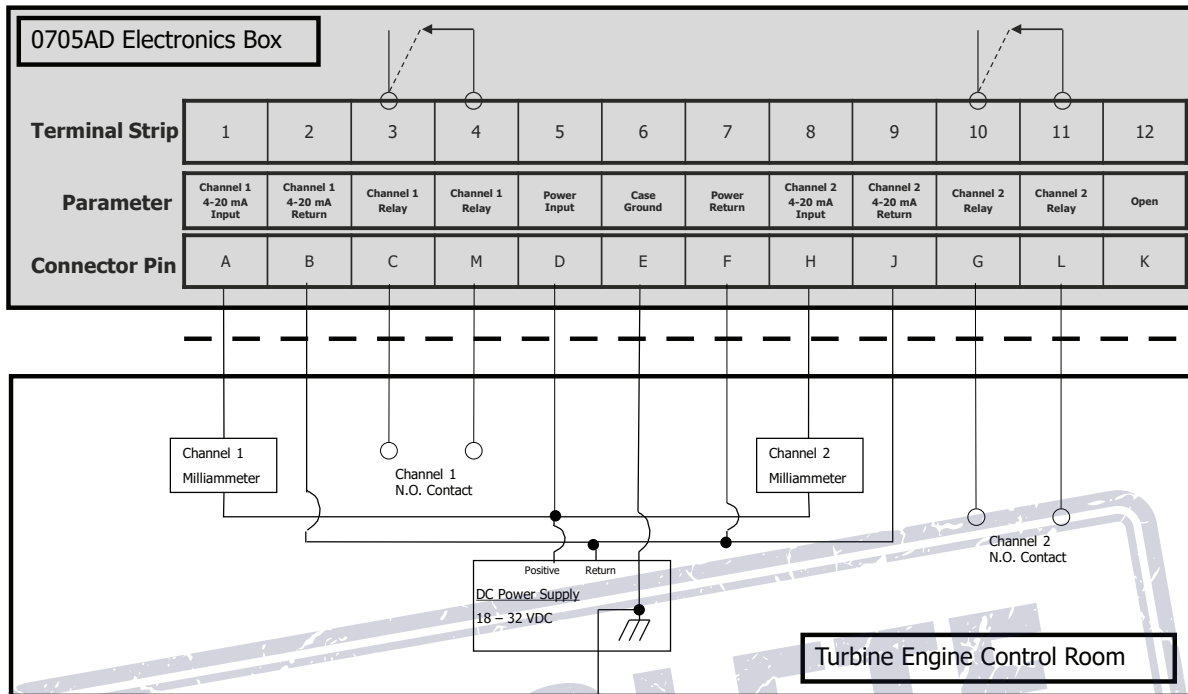

Figure 14 Simultaneous 4-20mA and Relay Operation Diagram

OBSOLETE

Section 3 Maintenance Procedures



WARNING

Do NOT open cover of electronics module box when explosive atmosphere may be present.

There are several optical surfaces for each channel in the 0705AD that should be verified as clean during regular maintenance.

The surfaces are:

- Detector filter window inside electronics enclosure cable fitting
- Combustor end of the fiber optic cable
- Electronics end of the fiber optic cable
- Lens surfaces inside FSA
- The LED viewing window may be cleaned by using a cotton swab or soft cloth soaked in alcohol.

3.1 Recommended Cleaning Materials

1. Cotton swabs, rigid type (6 inch wooden stick)
2. Acetone
3. Isopropyl alcohol, technical grade
4. If available, clean and dry compressed low pressure air or nitrogen gas supply

3.2 Procedure for Electronics End Optics

Dirt or contamination does not typically affect this end of the fiber optic cable, but if a visual inspection reveals a discrepancy, use the following procedure for cleaning:

1. Remove fiber optic cable from electronics enclosure exposing the photodiode optical filter (.100" diameter dark glass area). If foreign material is found, clean surfaces as described in the following steps.
2. Soak a clean cotton swab tip in alcohol and wipe filter window gently. Use care not to leave cotton residue. Use multiple swabs if required to remove all visual signs of contamination (do not re-use dirty swabs). Blow dry with compressed air or nitrogen or use a new swab to dry the window.
3. Soak another clean swab in alcohol and wipe the end of the fiber optic cable. Blow dry with compressed air or nitrogen or use a new swab to dry the end of the fiber optic cable.
4. Inspect parts for foreign material and possible damage. Repeat cleaning steps if any foreign material is found.
5. Mate parts while maintaining cleanliness (Do not touch the end of fiber optic cable).



CAUTION

Verify that no foreign objects are trapped inside the fiber optic cable connections.

3.3 Procedure for Cleaning Combustor End Optics

Due to the harsh environment surrounding the combustor, this end of the fiber optic cable is susceptible to contamination from foreign material being trapped on the optical interfaces. Use caution not to touch optical surfaces or allow foreign material to be deposited in the FSA or on the fiber optic cable end when servicing.

3.3.1 Aero derivative Type FSA

1. Remove fiber optic cable from FSA.
2. Soak clean cotton swab tip in alcohol and wipe end of fiber optic cable. Use care not to leave cotton residue. Use multiple swabs if required to remove all visual signs of contamination. Blow dry with compressed air or nitrogen or use a new swab to dry the end of the fiber optic cable.
3. Remove FSA from combustion chamber and inspect for contaminated optical surfaces. Use the wooden end of a cotton swab dipped in acetone to remove any heavy residue from the FSA window. Clean the FSA window surface using a cotton swab soaked in acetone to remove any remaining contamination. Repeat if necessary. Use care not to leave cotton residue. Use multiple swabs if required to remove all visual signs of contamination (do not re-use dirty swabs).
4. Perform final cleaning of the window surface using another clean swab soaked in alcohol. Blow dry with compressed air or nitrogen or use a clean swab to dry.
5. If contamination is found on the lens surface on the FSA end connecting to the fiber optic cable, use a clean cotton swab soaked in alcohol to clean the lens surface. Blow dry with compressed air or nitrogen or use a clean swab to dry. Repeat alcohol wash if necessary to remove any signs of contamination.
6. If any contamination appears inside the FSA (between the window and lens), contact Forney for instructions on lens removal and cleaning.
7. Inspect parts for foreign material and possible damage. Repeat cleaning steps if any is found.
8. Mate parts while maintaining cleanliness (Do not touch the end of fiber optic cable or window).

3.3.2 Frame Engine Type FSA

1. Remove fiber optic cable from FSA.
2. Remove the safety pin from clamp and loosen the clamp to allow removal.
3. Carefully remove the fiber optic-side of FSA and then the lens assembly.
4. Remove the gasket from engine side of the FSA and discard.
5. Soak clean cotton swab in alcohol and wipe the lens on both sides. Use care not to leave cotton residue. Use multiple swabs if required to remove all visual signs of contamination (do not re-use dirty swabs). Blow-dry with compressed air or nitrogen or use a new swab to dry the lens surface.
6. Inspect parts for foreign material and possible damage. Repeat cleaning steps if foreign material is found on lens. Return unit to Forney if damage is considered to affect performance.
7. Place new gasket in the engine mounted part of FSA.
8. Insert the lens assembly into the engine mounted part of the FSA.
9. Mate the fiber optic-side of the FSA onto the lens assembly.
10. Place clamp over the mating flanges and tighten clamp to 100 in-lbs (make sure lock washer is outside clamp).
11. Insert safety pin into the clamp.

Section 4 System Troubleshooting

The FlameHawk® flame detection system can be broken down into three sections. Proper troubleshooting will need to isolate the problem down to one of these: the FSA, Fiber Optic cable, or Electronics Module.

FSA and Fiber Optic Cable

A visual inspection will determine the condition of the FSA and the Fiber Optic cable.

- Is the FSA clean and free of any damage?
- Are the ends of the Fiber Optic cable clean?
- When light (flashlight or sun light) is transmitted thru one end of the cable, are all 19 fibers visible at the other end?

If there is contamination on any of the surfaces, clean using the proper procedure.

If there is any damage, replace as necessary.

Electronics Module

Verify that power is applied to the electronics. Check that the Power On LED is lit. If the power on LED is not lit, unscrew the cover and check voltage on the terminal strip, pins 5 and 7. If voltage is present, but no LED's are lit, there is a problem in the electronics module and it should be replaced.

Verify that the LED's change with signal strength. Remove the fiber optic cable at the housing and illuminate the Photodiode (flashlight or sunlight). Vary the amount of light and check that the LED's are varying with the light input. If not, replace the electronics.

Verify the correct operation of the Relay output and the 4-20ma output. This can be done at the module, by first disconnecting the wiring and monitoring the proper terminal pins for the appropriate output with a hand held meter. Check the wiring chart to determine the correct pins.

When monitoring the Relay output, the resistance indicated should vary from 10 ohms (light) to very high resistance (megohms) when dark.

When monitoring the current output, the current should vary from 4ma's to 20ma's with a changing light source from dark to light. If unable to get 20ma's output with full light input, check optics and FSA's for damage. If no damage is found, then consult Forney customer service for recommendations.

If the electronics module fails to perform as described, it needs to be replaced.

Section 5 RMA / Warranty

Forney Corporation warrants this product to be free of defective material and workmanship. Forney will replace this equipment as long as it is being used for its intended use and is found to be defective upon receipt up to the expiration of the warranty period.

Prior to returning any material to Forney, please contact your Forney customer service representative and provide the contract number or the customer purchase order number.

Section 6 Spare Parts

When ordering spare parts, contact Forney's Aftermarket Department via any one of the following methods and furnish the following information.

| E-mail | Phone | Fax |
|-----------------------|--|--------------|
| spares@forneycorp.com | 972-458-6100 or 972-458-6142 or 1-800-356-7740 (24-hour direct line) | 972-458-6600 |

1. Contract number
2. Customer purchase order number
3. For each part ordered, provide the following information:
 - a. Part number
 - b. Part description
 - c. Quantity required

There are three major subassemblies that makeup the FlameHawk® Flame Detector and each of these should be ordered separately by designating the part number and quantity:

| Part Number | Description |
|-----------------|--|
| 00705-0225-0007 | Amplifier, with Cable Connector (Replacement for Model 00705-0225-0003) |
| 00705-0225-0008 | Amplifier, without Cable Connector (Replacement for Model 00705-0225-0004) |
| 00705-0225-0005 | Amplifier, with Connector, Unfiltered |
| 00705-0225-0006 | Amplifier, without Connector, Unfiltered |
| 00705-0192-0120 | 10' Fiber Optic Cable |
| 00705-0192-0180 | 15' Fiber Optic Cable |
| 00705-0192-0300 | 25' Fiber Optic Cable |
| 00705-0192-0480 | 40' Fiber Optic Cable |
| 00705-0242-0001 | Cable, Interface |
| 00705-0185-0001 | Aeroderivative Sight Tube, Inconel/Sapphire |
| 00705-0212-0001 | Frame Type Primary Coupling Mounted Sight Tube, 316 SST, Quartz |
| 00705-0213-0001 | Frame Type Coupling Mounted Sight Tube, 316 SST, Quartz with Offset for Special Applications, Consult Forney |
| 00705-0239-0001 | Frame Type Secondary Flange Mounted Sight Tube, 316 SST, Quartz |
| 00705-0258-0001 | Replacement Quartz Lens Assembly for 00705-0212-0001 and 00705-0239-0001 |
| 00705-0269-0001 | Replacement Quartz Lens Assembly for 00705-0213-0001, Consult Forney |